

# Road Mate DVR ®

## User's Manual

Model: 7202



**Road Mate DVR** © 2011 All rights reserved.

Under the copyright laws, this manual may not be copied, in whole or in part, without the written consent of Road Mate DVR. Road Mate DVR makes no expressed or implied warranty of any kind and assumes no responsibility for errors or omissions. No liability is assumed for incidental or consequential damages arising from the use of the information or products contained herein. Features and specifications are subject to change without notice.

All other products and brand names are trademarks of their respective holders. No part of this user manual may be reproduced or transmitted in any form or by any means, electronic or mechanical, including photocopying and recording, for any purpose other than the purchaser's personal use.

Revised : 01-01-2015

## Table of Contents

<b>1. BEFORE USING YOUR CAR DVR</b>	<b>3</b>
Package Contents	3
Memory Cards Supported	4
Handling Cautions	4
<b>2. TECHNICAL SPECIFICATIONS AND FUNCTIONS</b>	<b>5</b>
Specifications	5
Functions	5
<b>3. IMPORTANT SAFETY WARNINGS</b>	<b>6</b>
IMPORTANT SAFETY WARNINGS	6
Operating Temperature	7
Battery Warnings	7
Insert SDHC Memory Card	8
Charging your car DVR	8
<b>4. QUICK START GUIDE</b>	<b>9</b>
3 Easy steps	9
<b>5. CONFIGURATION</b>	<b>11</b>
Introducing Your car DVR	11
Operations	12
Power on	12
Auto Recording	12
Manual recording	12
Pause Recording	12
Switch mode and display the Menu	12
Power off	12
Screen Display Status	13
Display the Menu	13
<b>Access the Setting Menu</b>	<b>14</b>
<b>Accessing Video Mode Settings &amp; Configurations</b>	<b>14</b>
Video Mode Settings	14
Video Size	14
Date Stamp	15
Motion detection	15
Loop Rec	15
Loop Time	16
Delay shutdown	16
Audio	16
<b>Video Configurations</b>	<b>17</b>
Sounds	17
Frequency	17
Power saving	17
Screen shut off	17
Date & Time	18
Language	18
Video system	18
Start-up Image	18
Format	18
IR LED	19
Reset All	19
Version	19
<b>Photo Mode Settings</b>	<b>19</b>
Resolution	20
Quality	20
Exposure	20
Timer	20
Date Stamp	20
<b>Playback Mode Settings</b>	<b>20</b>
<b>6. ACCESSING RECORDED VIDEOS</b>	<b>21</b>
<b>7. HOW TO REGISTER MY PRODUCT</b>	<b>25</b>
<b>8. ONE YEAR CONSUMER LIMITED WARRANTY</b>	<b>28</b>
<b>9. TROUBLESHOOTING AND FAQs</b>	<b>30</b>

**1.****BEFORE USING YOUR DRIVING RECORDER**

Thank you for purchasing Road Mate DVR. This user manual provides you with information to get started. Please read carefully and follow the instructions to connect and set up your car DVR. You may review the troubleshooting FAQs on last page.

**1.1 Package Contents**

Please check that the following items have been included with your package. If anything is missing, please contact your dealer.

---

Product Photo	Description	Qty.
	Road Mate 7202 Car DVR	1
	USB Cable	1
	USB Car Charger	1
	Windshield Suction Mount	1

## Memory Cards Supported

This package does not ship with a SDHC memory card; you need to purchase one separately. This device is compatible with class 10, UHS-3 SDHC memory card. A 32GB SDHC, class 10, UHS 1 or 3 SDHC memory card is recommended to use for this device. If an accident has occurred, please lock your SDHC memory card immediately, then remove your SDHC memory card and keep it safe with you for future evidence.

- This device supports up to 32GB SDHC Memory Card, Class 10 (See below some SDHC card images for your reference).

In case of SDHC memory card had bad sectors or not compatibility with video recording on this device, a “Card Error” message will appear on car DVR screen.



Make sure your SDHC memory cards write protect switch is set upward to enable writing/erasing.

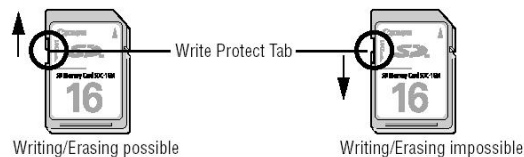

Make sure a SDHC card is inserted before recording video. DO NOT remove your SDHC memory card during recording videos.

## Handling Cautions

1. This device is a precision instrument. Do not drop it or subject it to physical shock.
2. This device is not waterproof and cannot be used underwater. If this device gets wet, wipe off any water droplets with a dry cloth, and promptly consult Road Mate DVR customer service ([info@roadmatedvr.com](mailto:info@roadmatedvr.com)).
3. Do not leave this device in places prone to excessive heat on a sunny day. Excessive heat can cause this device to malfunction. The operating temperature range is 14°F~158°F (-10°C~70°C).
4. This device contains precision electronic circuitry. Never attempt to disassemble the device.
5. Use only a blower brush to blow away dust or lens cleaner to clean the lens.

This cost-effective car DVR saves you money by preventing false claims towards you. It is a compact, face-forward digital recording system, records video/audio in case of any accidents or incidents that may have taken place and prevents false or fraudulent claims. This compact, lightweight car DVR is fitted to your vehicle windshield in order to record forward view during your journey.

This device is designed to record video and audio simultaneously when you drive on the road. It can also be used as a portable DV, camera, and web cam. The key features are as following:

### **Specifications**

- 120° wide angle lens.
- 4 night vision IR LEDs
- 2.5: TFT full color screen.
- 120° display angle
- Built-in speaker & microphone.
- Fixed focus, 50cm ~ infinity lens.
- Video format AVI, Video aspect 16:9
- 1/4" Full color CMOS 720p HD sensor
- Mode: video/recorder/camera/webcam
- Built-in 500 mAh Li-ion rechargeable battery.
- Supports SD/SDHC memory card up to 32 GB
- Recording resolution: HD 1920 X 1080 (Interpolation), 1280 X 720, 848 X 480 (D1) @ 30 fps.
- File format: FAT32; Video Format: AVI; Still Image Storage Format: JPEG
- USB 2.0 connectivity: USB port connect to PC; AV out connect to TV.
- Package weight: 434g; Product size (folded): 106x62x33mm
- Operating temperature range is 14°F ~ 158°F (-10°C ~70°C)
- Power supplied by car charger or USB port (Input: DC 12V~24V, Output: DC 5V, 1 Amp)

### **Functions**

- Parking motion detection.
- Adjustable recording time slice
- Loop recording video and audio.
- Real-time date/time stamp on video
- 11 international languages user interface.
- Supports Real Time & Date stamp on video.
- Auto power on/off, when car engine ignites and turns off.
- Supports SDHC memory card up to 32GB (**SDHC card excluded from the package**).

**IMPORTANT SAFETY WARNINGS**

This device is an advanced portable vehicle digital video recorder (also known as car DVR, dash cam, or car cam etc), it is designed to record video and audio when you are driving on the road. When you are using the Road Mate car DVR, the following safety rules must be followed to prevent accidents that may result in injury to yourself or others.

1. Please check the applicable regulations in your state regarding device mounting on windshield; some states prohibit the mounting of any items on your windshield. This car DVR is not a life-saving device. You may use recorded video/audio files to provide evidence in the event of an incident or accident. Please consult your legal counselor if you involved in an accident.
2. It is your responsibility to comply with traffic laws and to use or mount the Road Mate DVR in such a manner that is compliance with applicable laws.
3. When installing this device on your vehicle windshield, make sure it is secure and does not obstruct the driver's visibility of the road. It is your responsibility as the vehicle operator to securely place the device that will not interfere and prevent the operations of the vehicle's safety devices (such as air bags) in your vehicle. Do not place or mount this device unsecured and in a place where the driver or passengers may receive injury during vehicle operation or collision. For your safety, take care to route all cables away from shifters, pedals, accessory controls and other control mechanisms.
4. Keep your eyes on the road. The vehicle's operator should not be distracted by this device or software while driving and always be fully aware of all driving conditions. Minimize the amount of time spent viewing the device screen while driving. Do not change settings or access any functions requiring prolonged use of the device controls while driving. Should there be a distraction with the ability to drive responsibly, please pull over in a safe and legal manner before attempting such operations.
5. The windshield mount may not stay attached to the windshield in all circumstances. Do not place the mount where it will become a distraction, if the mount should become detached. Keep your windshield clean to help ensure that the mount stays on the windshield.
6. Keep this device safe from extreme temperature conditions. For example, do not leave this device exposed to direct sunlight for an extended period of time. The operating temperature range of this device is 14°F ~ 158°F (-10°C~70°C). This device is not designed for outdoor use. Do not place this device in wet and dusty environments in order to avoid the lens and other components to become dusty and thus, affect the camera effects.

7. Do not use harsh chemicals, cleaning solvents or cleaning agents to clean the device. Use a slightly damp soft cloth to clean the device.
8. Do not use any batteries, power sources, and accessories that do not come with the original package. Do not use any home-made or modified batteries.
9. Do not short-circuit, disassemble, or modify this device or battery pack.
10. Do not leave any cords near a heat source. It can deform the cord or melt the insulation and cause a fire or electrical shock.
11. A tinted windshield will cause video clarity or color distortion.

## **Operating Temperature**

- This device operating temperature range is 14°F ~ 158°F (-10°C ~70°C). Temperatures below or over the operating temperature may cause damage. The limited factory warranty will be voided if your device is subjected to temperatures outside the operating temperature range.

## **Battery Warnings**

If the guidelines below are not followed, the internal lithium-ion battery may experience a shortened life span or may present a risk of damage to this device, fire, chemical burn, electrolyte leak, and/or injury.

- The battery in this car DVR is rechargeable and should not be removed or replaced with other specifications. In the event that it should need to be replaced, please contact Road Mate DVR technical support ([info@roadmatedvr.com](mailto:info@roadmatedvr.com)).
- Do not leave this device exposed to a heat source or in a high temperature location, such as in the sun in an unattended vehicle. To prevent damage, remove the device from the vehicle or store it out of direct sunlight.
- Do not puncture or incinerate the device or battery.
- Do not operate this device outside of the following temperature range from 14°F ~ 158°F (-10°C ~70°C). When storing the device for an extended time, store within the following temperature range: 32°F to 77°F (0°C~25°C).
- If using an external battery charger, only use the Road Mate DVR accessory approved for your product.
- Only replace the battery with the correct replacement battery. Using another battery presents a risk of fire or explosion. To purchase a replacement battery, see your Road Mate DVR dealer or the Road Mate DVR web site.
- Do not remove or attempt to remove the non-user-replaceable battery.

## Insert SDHC Memory Card

- Insert your SDHC memory card to the rear of car DVR (refer photo below).



## Adjust suction mount



Steps to adjust suction mount

## Connecting your car DVR

- No pre-charge needed. Connect the car charger that comes with the package, between the car DVR and your vehicle cigarette lighter. Using a different type of adapter or car charger can result in malfunctions and/or possible fire hazard due to battery overheating.
- For safety reasons, the battery in this device will stop charging when the ambient temperature is less than 32 °F (0° C) or more than 158°F (70° C).
- To obtain a fully charged battery, it is recommended that you charge the battery initially for at least 2 hours.
- When connecting to and using a household power outlet, use only AC/DC Adapter (rated input: 100~240V AC, 50/60 Hz, rated output: 5V, 1~1.5A DC). Using anything else can cause fire, overheating, or electrical shock.



### 3 easy steps

Installation of the Road Mate DVR is very easy and simple. Please read the safety guidelines carefully.

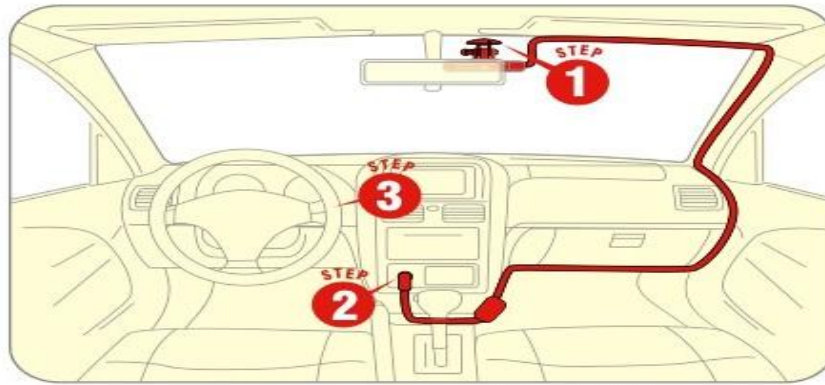

STEP

1

#### Install suction mount

- Find a safe location on the interior of vehicle's windshield to mount the pedestal.
- Use windows cleaner or alcohol pad to clean up internal windshield surface that has been selected for mounting the car DVR. Let the area dry completely before you mount the pedestal.

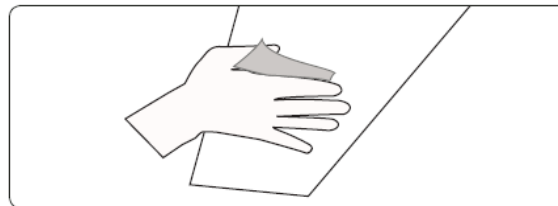

- Firmly push the suction base against the windshield and flip the base lever down to the locked position. Adjust the angle of the pedestal arm by tightening the angle adjustment knob to the desired angle. Be sure it will not interfere with your view of the road.





For your safety, avoid routing the cable from shifters, pedals, accessory controls, and do not place the suction mount near airbags deployment zone or where it will obstruct your view.

STEP

2

### **Route the car charger cable and connecting power.**

- Plug the car charger into your vehicle power receptacle (cigarette lighter socket), and connect the USB connector to the car DVR USB port. Route the car charger power cord along the windshield edge. Be sure to stay away from the side air bags shifters, pedals, accessory controls and other control mechanisms.

**Note:** If the power-on indicator remains OFF, please turn your vehicle to ignition position.

STEP

3

### **Starts car engine and get recording.**

Ignite your car engine- the car DVR will automatically power on.



### **Safety Precautions**

Follow all safety guidelines for operating your device. Failure to practice safe usage of this device while driving may result in damage, injury, or death. Road Mate DVR is not responsible for any damages caused to your car, your device, or yourself due to the installation or use of this pedestal mount.

## Introducing Your car DVR

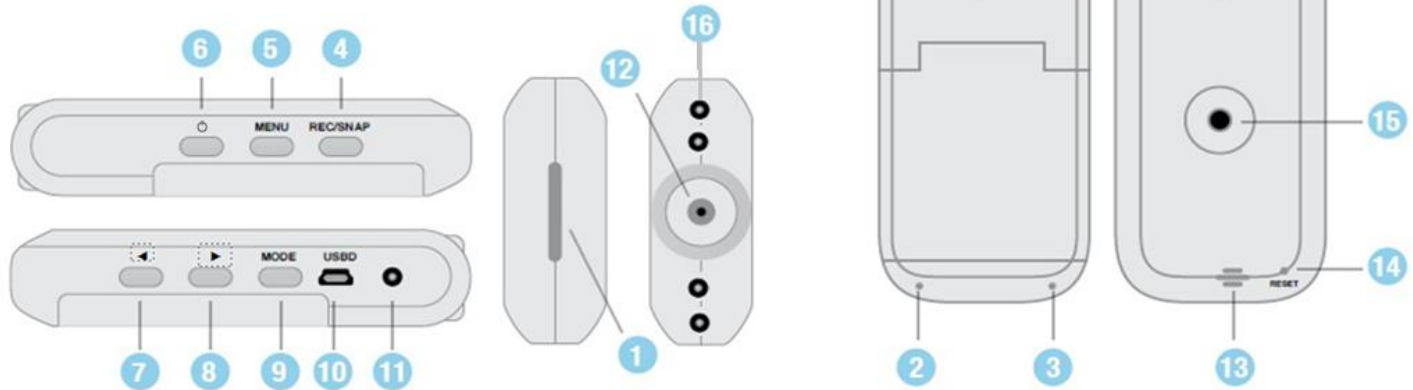



- |   |                |            |
|---|----------------|------------|
| 1. SD/MMC Card Slot                                     | 8. Up          | 16. IR LED |
| 2. Working (Blue) Indicator<br>Charging (Red) Indicator | 9. Mode Button |            |
| 3. Microphone   | 10. USB Slot   |            |
| 4. REC / Snap   | 11. AV Output  |            |
| 5. Menu   | 12. Lens       |            |
| 6. Power  | 13. Speaker    |            |
| 7. Down   | 14. Reset Hole |            |
|   | 15. Mount Hole |            |

**MENU:** Indicates a function can be changed by pressing the  button to changing the settings.

**DOWN:** Indicates the navigation down button, by pressing the  button.

**UP:** Indicates the navigation up button, by pressing the  button.

**MODE:** Indicates a mode can be changed by pressing the  button and change to “Video mode”, “Photo mode”, “Voice recorder mode” and “Playback mode.”

**POWER:** Indicates power on, by pressing the  button.

**OK:** Indicates start/stop recording and to confirm an action by pressing the  button.

## Operations

### ■ Power on

Ignite your car engine to power on the car DVR or press  button.

### ■ Manual Recording





For manual recording, press the  button.

### ■ Pause Recording

While recording video, you may press  button to pause recording.

### ■ Switch Mode & Display the Menu

■ **Mode:** After powered on, press  button to select mode below.

-  **Video mode**
-  **Camera mode**
-  **Voice recorder mode**
-  **Playback mode**

■ **MENU:** Once a mode is selected, press  button to go to settings.

### ■ Power off

a). **Auto power off:** the car DVR will auto off when engine turns off.

b). **Manual power off/on:** (if cigarette receptacle is consistent hot).

-Turn off: Hold [POWER] button 3 seconds to turn off DVR

-Turn on: Hold [POWER] button 3 seconds to turn on DVR

## Screen Display Status

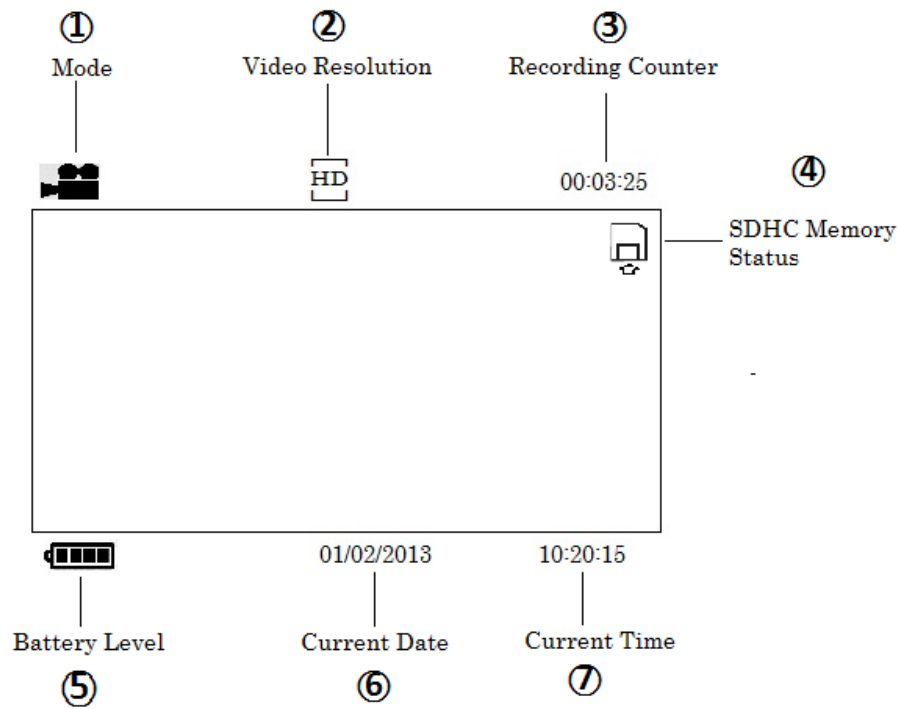









- ① → Mode: Display current mode.
- ② → Video Resolution: Display current video resolution.
- ③ → Recording Counter: Display video recording time.
- ④ → SDHC Memory Status: Display current SDHC memory card status.
- ⑤ → Battery Level: Display current battery power level.
- ⑥ → Current Date: Display current date.
- ⑦ → Current Time: Display current time.

## Access the Setting Menu

Press the  button to display the **Menu**.

\*. While video is recording, press  button to pause, and then press  button to access Menu.

## Accessing Video Mode Settings & Configurations



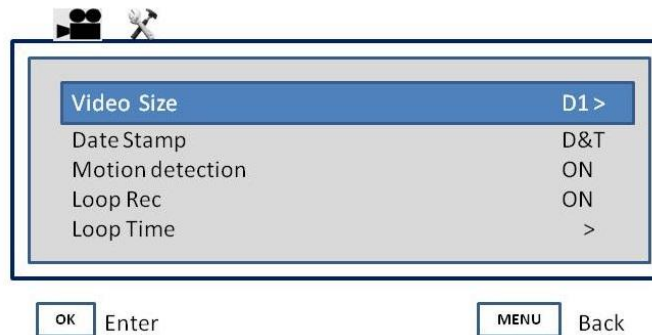

1. Under video mode () , press the  button to access setup interface. In the setup interface, use the navigation buttons  or  to select the desired mode and then press the  button to access selection.
2. Press  button to select “Video Settings”  or “Configuration” .

### Video Mode Settings



■ **Video Size:** Allows you to choose between the different video resolutions.

- ▶ [FHD]      **1920 X 1080 (Interpolation mode)**
- ▶ [HD]      **1280 X 720 (Real HD mode)**
- ▶ [D1]      **848 X 480**
- ▶ [640]      **640 X 480**

1. To change video resolution, select **Video Size**, then press navigation button  or  to select, and press  to confirm your selection.
2. Press  to select. Press  back to main menu.

■ **Date Stamp:** Allows you to add current date/time watermark on video.

1. To enable or disable date stamp on video, press **DOWN** or **UP** button to select **Date Stamp**, and then press **OK**.
2. Press **OK** to confirm. Press **MENU** back to main menu.

■ **Motion detection:** Set this feature only when you are parking.

(Set "Motion detection" OFF when you are driving)

1. To enable or disable motion detection feature, press **DOWN** or **UP** button to select **Motion detect**, and then press **OK** button.
2. Press **OK** to confirm. Press **MENU** back to main menu.

■ **Loop Rec:** Set SDHC card loop recording.







1. To enable or disable SDHC card loop recording, press **DOWN** or **UP** button to select **Loop Rec**, and then press **OK** button.
2. Press **DOWN** or **UP** button to select "On" or "Off."
3. Press **OK** to confirm. Press **MENU** back to main menu.

(Set "Loop Rec" OFF, the SDHC memory card will not loop unit it is full)

■ **Loop Time:** Allows you to set the interval of recording time to 2, 5 or 10 minutes segment.







1. Press **DOWN** or **UP** button to select **Loop Time**, and then press **OK** button.
2. Press **DOWN** or **UP** button to select "2 Min.", "5 Min.", "10 Min."
3. Press **OK** to confirm. Press **MENU** back to main menu.

■ **Delay shutdown:** Turns off the car DVR in “X” minutes after power is off.

1. Press  or  button to select **Delay shutdown**, and then press .
2. Press  or  button to select “Off”, “10 Min.”, “20 Min.”
3. Press  to confirm. Press  back to main menu.











\*. This feature only applied for cigarette receptacle is powered by ignition.

■ **Audio:** To enable or disable microphone, while recording video.

1. To enable or disable audio while video is recording. Press  or  button to select **Audio**, and then press  button.
2. Press  or  button to select “On” or “Off”.
3. Press  to confirm. Press  back to main menu.

## System Configurations

■ **Sounds:** To change the chime of power on and power off.

1. Press  button to select **Sounds**, and then press  button.
2. Press  or  button to select
  - a. Press  to select Shutter “On” or “Off”.
  - b. Press  to select Start-up chime “1”, “2”, “3” or “None”
  - c. Press  to select Beep “On” or “Off”
  - d. Press  to select Volume level “0”, “1”, “2”, or “3”. Volume level 0 is silent.
3. Press  to confirm. Press  back to main menu.



■ **Frequency:** To set the frequency of your player system.

1. Press **DOWN** or **UP** button to select **Frequency**, and then press **OK** button.
2. Press **DOWN** or **UP** button to select “50Hz” or “60Hz”.
3. Press **OK** to confirm. Press **MENU** back to main menu.

■ **Power saving:** Power saving is the duration of time that this device screen remains idle.

1. To set the system idle time. Press **DOWN** or **UP** button to select **Power saving**, and then press **OK**.
2. Press **DOWN** or **UP** button to select “1 Min.”, “3 Min.”, “5 Min.” or “Off”.
3. Press **OK** to confirm. Press **MENU** back to main menu.

■ **Screen shut off:** Allows you to set the screen shut off after X time is displayed.







1. To set the screen shutoff time. Press **DOWN** or **UP** button to select **Screen shutoff**, and then press **OK** button.
2. Press **DOWN** or **UP** button to select “30 Sec.”, “1 Min.”, “2 Min.”, or “Off”.
3. Press **OK** to confirm. Press **MENU** back to main menu.

\*. Press **OK** to display the screen, while the screen shut off feature is in effect.







■ **Date & Time:** Allows you to set the current date and time.

1. Press **DOWN** or **UP** button to select **Date & Time**, and then press **OK**.
2. Press **MODE** 6 times, to MM/DD/YYYY then press **DOWN** or **UP** to select your date format type. Press **MODE** after you select your Date format.
3. Press **DOWN** or **UP** button to set month, date, year, hour, minute, and second. Press **MODE** for each section.
4. Press **OK** to confirm. Press **MENU** back to main menu.







■ **Language:** Allows you to select the desired language of user interface.

1. Press  or  button to select **Language**, and then press  button.
2. Press  or  button to select your language.
3. Press  to confirm. Press  back to main menu.







■ **Video system:** To select your video system.

1. Press  or  button to select **Video system**, and then press .
2. Press  or  button to select “NTSC” or “PAL”.
3. Press  to confirm. Press  back to main menu.







■ **Start-up Image**

1. Press  or  button to select **Start-up Image**, and then press .
2. Press  or  button to select “Off” or “System”.
3. Press  to confirm. Press  back to main menu.







■ **Format:** Allows you completely erase all data from the SDHC memory card.

1. Press  or  button to select **Format** your SDHC memory card, and then press .
2. Press  or  button to select “Yes” or “No”.
3. Press  to confirm. Press  back to main menu.





■ **IR LED:** Allows you to set infrared LED to night vision.

1. To enable or disable IR LED. Press  or  button to select **IR LED (Infrared LED)** on or off, and then press .
2. Press  or  button to select “On” or “Off”.
3. Press  to confirm, press  back to main menu.

■ **Reset All:** Allows you to restore this device back to original factory settings.

1. To reset settings back to factory default, press  or  button to select **Reset All**, and then press  button.
2. Press  or  button to select “Yes” or “No”.
3. Press  to confirm. Press  back to main menu.



■ **Version:** Indicates current firmware version of the device.

1. To view firmware version, press  or  button to select **Version**, and then press  button.
2. Press  to confirm. Press  back to main menu.
- 3.



## Photo Mode Settings

■ **Resolution:** Allows you to choose between the different photo resolutions including:

- ▶ 5M 2592 X 1922
- ▶ 3M 2048 X 1536
- ▶ 2M 1600 X 1200
- ▶ 1M 1280 X 1024

1. To change photo resolution, select **Resolution** on screen, then press  button.
2. Press  to select, press  back to main menu.



- **Quality:** Allows you to set the resolution number of dots per inch in a image.

- ▶  **Super Fine**
- ▶  **Fine**
- ▶  **Normal**

- **Exposure:** Allows you set the amount of light to fall on each area of image.



- **Timer:** Allows you to set the respective function remains in effect for “Off”, “2 seconds”, “10 seconds” or “Burst” respectively after the button is confirmed.

- ▶ **Off**
- ▶  **Self-timer 2 Sec.**
- ▶  **Self-timer 10 Sec.**
- ▶  **Burst** (Allows you to shoot up to about 3~4 shots per sec.)

- **Date Stamp:** Allows you to stamp the date on photos.

- ▶ **Off**
- ▶ **Date/Time**

## Playback Mode Settings

- **Lock:** Allows you to lock one or all video files.
  - ▶ **Lock/Unlock one** (To lock or unlock one selected video file)
  - ▶ **Lock All** (To lock all video files)
  - ▶ **Unlock All** (To unlock all video files)

■ **Delete:** Allows you to delete one or all video file(s).

- ▶ **One** (To delete one selected video file)
- ▶ **All** (To delete all video files)

You can either select and erase videos one by one or erase them in one batch. Once an image is erased, it cannot be recovered. Make sure you no longer need the image before erasing it.

## **Maintenance**

Routine clean your camera lens with lens cleaner or a soft eyeglass cloth.

\*. Do not use any kind of solvent to wipe the car DVR and the camera lens.

## 6.

## ACCESSING RECORDED VIDEOS

### Connecting Diagram

Below diagram shows several ways to connect your car DVR to a TV unit and computer, and the ways to read your recorded video files.

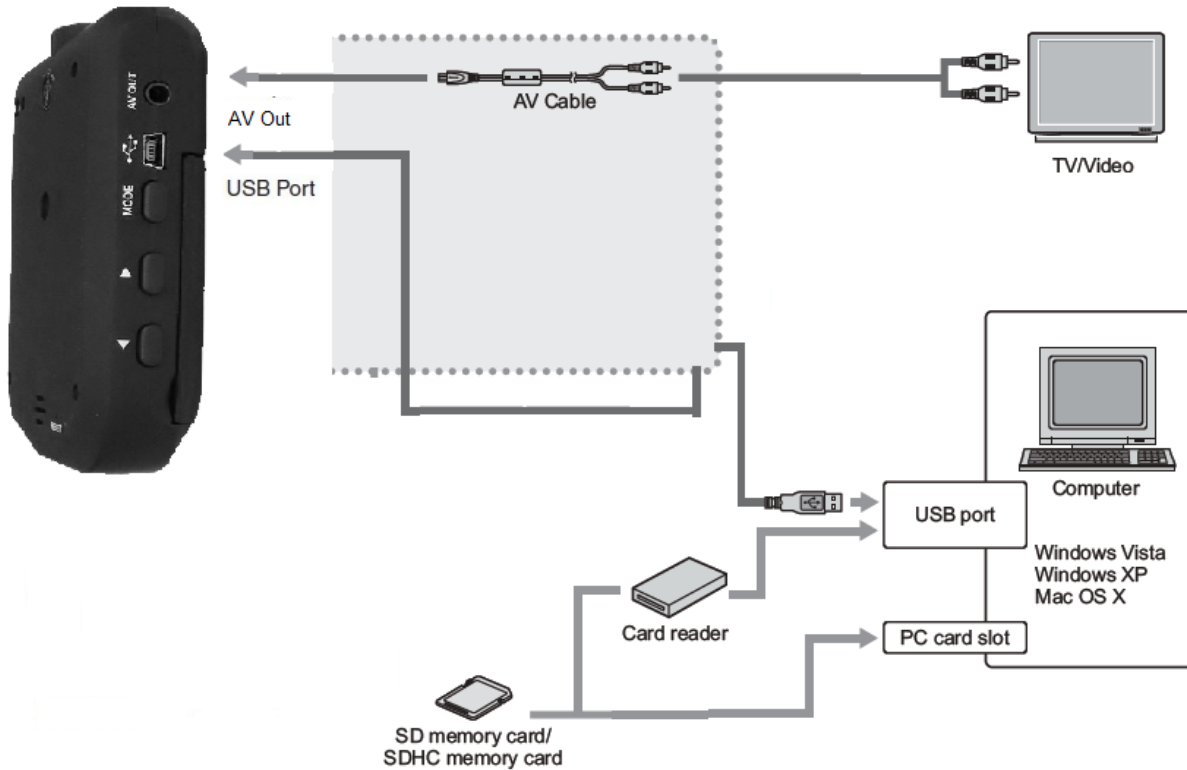

### ■ Accessing Files via Connecting USB Port to a Computer

By connecting the car DVR to a computer, you can transfer videos and photos from the SDHC memory card. The videos sent to the computer will be displayed in the folder of [My Computer] \ SD Disk in subfolder organized according to the shooting date.

1. Connect your car DVR to a computer via USB cable.

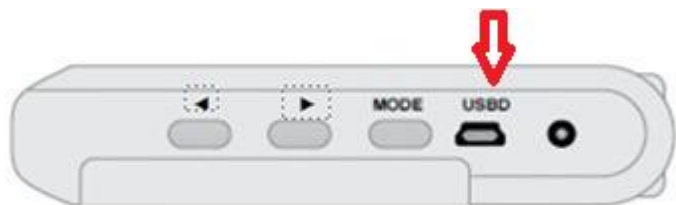
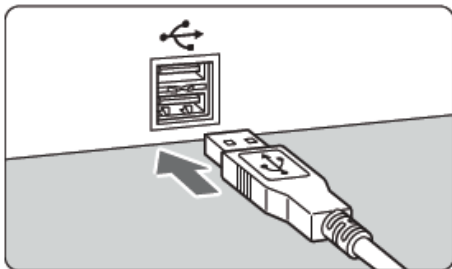

2. Press  button to select **MSDC**, while the car DVR display as below

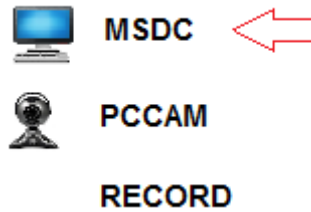

3. Additional window will appear your “SD Disk” folder. You may also find on “My Computer”.

### ■ Accessing files via inset SDHC card to computer card reader

1. Remove your SDHC card from the car DVR
2. Insert your SDHC card to your computer card reader.
3. The “SD Disk” icon will appear on “My Computer”.
4. The recorded files will be stored similar the contents of a flash drive.



## ■ Viewing the live video on (Non-HD) TV set

You can view the live video on a TV set. Simply connect the car DVR to a TV set via the AV output by using a RCA cable and enter the DVR into Preview mode.

### 1. Connect the AV cable to the car DVR.



### 2. Connect the AV cable to the TV set.

- Connect the AV cable to the TV's video IN terminal and the audio IN terminal. Red terminal for video output, White terminal for audio output.
- Set your car DVR video format to NTSC in USA.

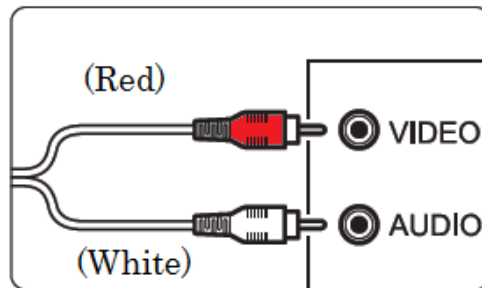

### 3. Turn on the TV and switch the TV's video input to select the connected terminal.

### 4. Press the car DVR button.

- The image will appear on the TV screen. (Nothing will be displayed on the car DVR screen)
- If your video system format does not match the TV's, the images will not be displayed properly. Set the proper video system format with **Video System** between NTSC and PAL.



## 7.

## HOW TO REGISTER MY PRODUCT

By registering your Road Mate DVR product, you will receive one year limited factory warranty from the date of purchase (refer one year limited warranty). Please visit the [Road Mate DVR registration page](http://www.roadmatedvr.com) online at <http://www.roadmatedvr.com>, then follow the steps below.

1. Click on “registration.”



2. Create your account.

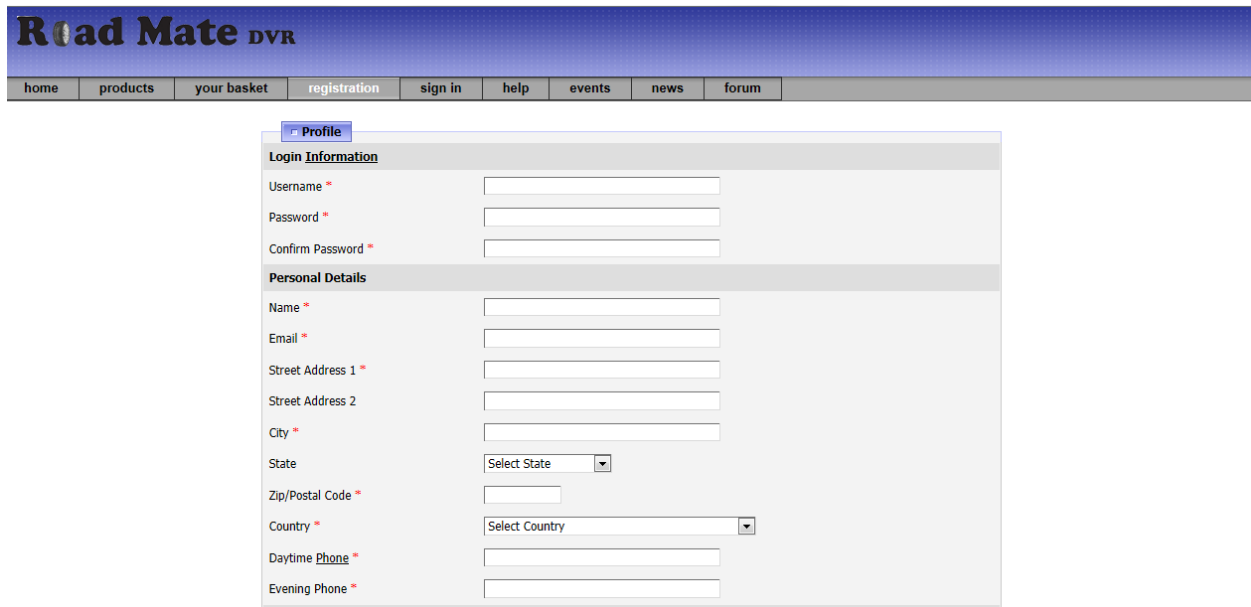

3. Once your account is created, select “My Registered Products” as shown below.

**Road Mate DVR**

home products your basket user home sign out events news forum

My Account

Home Page

**My Orders**  
Once you have placed your order with us you will be able to track the status of your order and review the order details.

**My Support Requests**  
If you experience any problems with the products you have purchased, our Support Team are ready to help. Feel free to [contact us](#) by clicking above link to submit a Support Request.

**My Registered Products**

**My Saved Carts**  
Here you can view/retrieve baskets saved in the past.

**My Reminders**  
My Reminders

**Change your details**  
Change the contact or login information you entered when creating your account. The link below will take you to the page were you can change your password  
▶ **Change password**

**My Forum Topics**  
Have you ever wondered if the problem you are having is one that someone else has experienced? Would you like to share your expertise with [new](#) users? Why not become a Forum user and join the community?

**My Ads**  
If you have items that you would like to sell, place an ad here. It's quick and easy to [place ads](#).

**My Wishlist**  
Here you can view wishlist items saved in the past.

[Logout](#)

News | Frequently Asked Questions | Links | Images | Events | Site Map

4. Click “Register Product.”

**Road Mate DVR** Stop (Esc)

home products your basket user home sign out events news forum

My Account > My Registered Products

My Registered Products

No Product Registrations

[Register Product](#)

News | Frequently Asked Questions | Links | Images | Events | Site Map

5. Enter your product information on each field. Refer to the example below:

- a. Product Name: Road Mate DVR
- b. Code: 7202 (The model number)
- c. S/N: RM 12029 (Product serial number- it can be found on the rear side of the DVR.)



- d. Invoice Number
- e. Purchase from (store name):
- f. Date of purchase:

**Road Mate DVR**

home products your basket user home sign out events news forum

My Account > My Registered Products > Register Product

Register Product

Product Name

Code

S/N \*

Invoice Number \*

purchased from (Store name) \*

Date of purchase \*  Month  Year

Im done registering Register more products Cancel

**8.****ONE YEAR CONSUMER LIMITED WARRANTY**

Road Mate DVR products are warranted to be free from defects in materials or workmanship for one year from the date of purchase. Within this period, Road Mate DVR will, at its sole option, repair or replace any components that fail in normal use. Such repairs or replacement will be made at no charge to the customer for parts or labor, provided that the customer shall be responsible for any transportation cost. This warranty does not apply to: (i) cosmetic damage, such as scratches, nicks and dents; (ii) consumable parts, such as batteries, unless product damage has occurred due to a defect in materials or workmanship; (iii) damage caused by accident, abuse, misuse, water, flood, fire, or other acts of nature or external causes; (iv) damage caused by service performed by anyone who is not an authorized service provider of Road Mate DVR; or (v) damage to a product that has been modified or altered without the written permission of Road Mate DVR. In addition, Road Mate DVR reserves the right to refuse warranty claims against products or services that are obtained and/or used in contravention of the laws of any country.

Repairs have a 90 day warranty. If the unit sent in is still under its original warranty, then the new warranty is 90 days or to the end of the original one year warranty, depending upon which is longer. The warranties and remedies contained herein are exclusive and in lieu of all other warranties express, implied, or statutory, including any liability arising under any warranty of merchantability or fitness for a particular purpose, statutory or otherwise. This warranty gives you specific legal rights which may vary from state to state. In no event shall Road Mate DVR be liable for any incidental, special, indirect or consequential damages, whether resulting from the use, misuse or inability to use this product or from defects in the product. Some states do not allow the exclusion of incidental or consequential damages, so the above limitations may not apply to you.

Road Mate DVR retains the exclusive right to repair or replace (with a new or newly-overhauled replacement product) the device or software or offer a full refund of the purchase price at its sole discretion. Such remedy shall be your sole and exclusive remedy for any breach of warranty.

To obtain warranty service, contact your local Road Mate DVR authorized dealers or Road Mate DVR Product Support for shipping instructions and an RMA tracking number. Securely pack the device and a copy of the original sales receipt, which is required as the proof of purchase for warranty repairs. Write the tracking number clearly on the outside of the package. Send the device, freight charges prepaid, to Road Mate DVR warranty service station.

Online Auction Purchases: Products purchased through online auctions (this does not apply to purchases made on [www.roadmatedvr.com](http://www.roadmatedvr.com)) are not eligible for warranty coverage. Online auction is not accepted for warranty. To obtain warranty service, an original or copy of the sales receipt from the original retailer is required. Road Mate DVR will not replace missing components from any package purchased through an online auction.

**To obtain warranty service, please complete these easy steps:**

**① Contact our Technical Support to receive an RMA number.**

E-mail Road Mate DVR technical support. Describe the problem and request a Return Material Authorization (RMA) number. You will need to provide the unit's serial number (if applicable), your return shipping address and a daytime phone number.

**Email:** [info@roadmatedvr.com](mailto:info@roadmatedvr.com)

**② Ship the unit, along with the RMA number, to us.**

Once you have received the RMA number, you need to include your RMA number in the shipping address. You need will packed the returning item and ship the package (prepaid and insured) to the following address and include the assigned RMA number: Please allow 5~7 working days to process your case.

RoadMate DVR Customer Service  
942560 PO BOX  
Miami, FL. 33194  
RMA Number: (write your RMA number here)

Contact Road Mate DVR Customer Support Email: [info@roadmatedvr.com](mailto:info@roadmatedvr.com)

Monday–Friday: 9 am–5 pm Eastern Time (closed holidays)

If a problem occurs, first refer to this troubleshooting guide. If this troubleshooting guide does not resolve your problem, contact your dealer or Road Mate DVR service center ([info@roadmatedvr.com](mailto:info@roadmatedvr.com))

### ■ Power related problems

- **The battery cannot be recharged.**
  - Check if the car charger connection and make sure the car charger power indicator is on.
- **The car DVR does not operate even when the power button is pressed.**
  - Check if the car charger is well connected to cigarette lighter. The power indicator on car charger should be lit on.
  - If you use the car DVR without power supported for a prolonged period, direct connect to car charger to use, no need to recharge the battery before use.
  - Try to reset the car DVR.

### ■The car DVR records video on and off.

- The motion detection feature is in effect.
  - Set the “motion detect” OFF when you driving.







### ■The car DVR screen turns off by itself.

- The screen shut off feature is in effect.
  - If you do not want screen shut off feature to take effect, set “Panel protect” to OFF

### ■ Memory related problems.

- **Screen shows “Car Error” message.**
  - Your SDHC memory card may not compatible with full HD video recording; try with other memory card (refer suggested SDHC memory cards on page 3).
- **No videos can be recorded.**
  - Your SDHC memory card is not properly inserted.
  - Press [OK] button to start/stop recording.

- Your SDHC memory card may slide to write-protect position.
- Your SDHC memory card may have bad sectors. Format your SDHC memory card by following steps.

- 1. Press the  button to display the menu.
- 2. To format your SDHC memory card. Press  or  button to select **Format**, and then press  button.
- 2. Press  or  button to select “Yes” or “No”.
- 3. Press  to confirm, press  back to main menu.

- **The SDHC memory card cannot be accessed.**

- Remove and insert your SDHC memory card again.
- Format your memory card.
- Try to replace with another memory card.

- **What type of format should I select if I want to use my computer to format SDHC memory card?**

- You need to use **FAT32** file system to format your memory card.

- **Screen shows “Memory full” and cannot save videos.**

- Set “Loop Rec” to ON.
- SDHC card has bad sectors that cannot be looped record.
- Hidden files may saved in your SDHC memory card.
- Format your SDHC memory card.
- The SDHC memory card may have error sectors or try to use another SDHC memory card.

- **Do I need to format a brand new SDHC card?**

- No. You do not need to format your new SDHC memory card.

- **Why is my recorded video blurry?**

- The camera lens maybe remains finger print. Clean with a lens cleaner or eyeglass cloth.
- You need to routine clean up both the exterior and interior windshield.

■ I use a Class 10 SDHC memory card, but when I play the video, it lags a little on my computer screen.

- This is due to the data transfer rate between the car DVR to your computer or the reading/writing speed of card reader on your computer too slow.
- You may copy the video files to your computer, then direct play the videos on your computer.

■ Why does my car DVR screen freeze?

- The SDHC memory card may have bad sector(s). The car DVR cannot write video file into your SDHC memory card while recording video. Try to format your SDHC memory card.
- Try to reset the car DVR (refer "How to Reset My Product").

■ Where is the product serial number?

- The product serial number can be found on the rear side of car DVR. Refer to the photo shown below.



■ How do I reset my car DVR?

- Utilize a thin paper clip (refer image shown below), then gentle pin the "Reset" hole (refer below image) for one second. The system will reset to your initial settings and your video files will not be lost.





■ **What is the view angle of my car DVR?**

The view angle of lens is 120° wide angle. It takes the view in front of your vehicle without distortion.

